

**2 Way 0° Power Divider  
5-1000MHz**

**MAPDCT0029  
V1P**

**Features**

- Surface Mount
- 2 Way 0 degree
- 260°C Reflow Compatible
- RoHS\* Compliant
- Available on Tape and Reel. Reel quantity 900

**Description**

M/A-COM's MAPDCT0029 is 2 way 0 degree RF power divider in a low cost, surface mount package. A 160 Ohm resistor included on the component. Ideally suited for high volume CATV/Broadband applications.

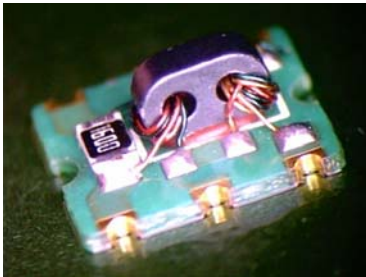

**Schematic**

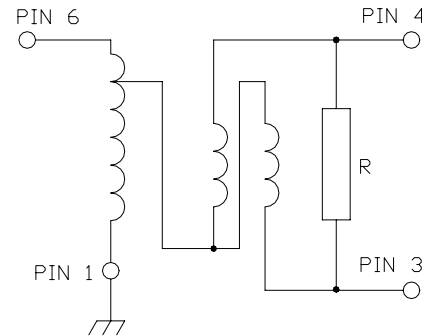

**Pin Configuration**

Pin No.	Function
1	Ground
2	Not connected (ground)
3	Output 2
4	Output 1
5	Not connected (ground)
6	Input

**Case Style: SM-55**

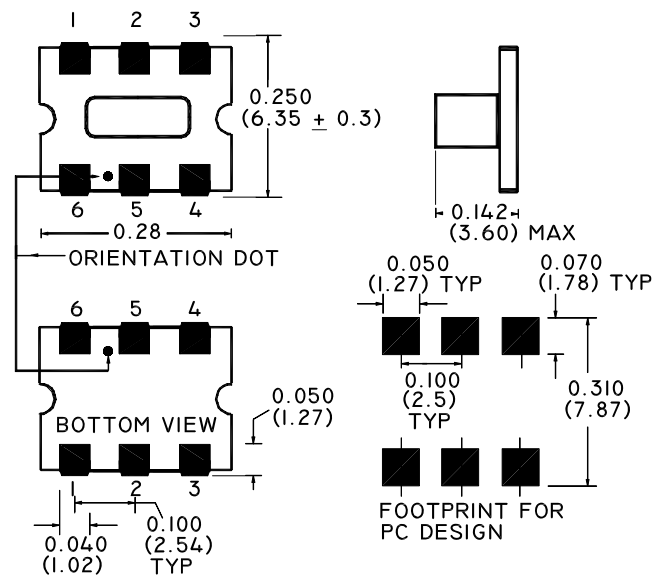

Dimensions in inches [mm] Tolerance: .xx ± .02, .xxx ± .010

**Ordering Information**

Part Number	Package
MAPDCT0029TR	900 piece reel

Note: Reference Application Note **M513** for reel size information.

\* Restrictions on Hazardous Substances, European Union Directive 2002/95/EC.

**Electrical Specifications:  $T_A = 25^\circ\text{C}$ ,  $Z_0 = 75\Omega$ <sup>1</sup>**

Parameter	Test Conditions	Frequency	Units	Min	Typ	Max
Insertion Loss	-	5 - 500 MHz	dB	-	0.5	0.7
Insertion Loss	-	500 - 1000 MHz	dB	-	0.7	1.4
Amplitude Unbalance (Nominal 0dB)	-	5 - 1000 MHz	dB	-	± 0.28	± 0.55
Phase Unbalance (Nominal 0°)	-	5 - 1000 MHz	°	-	± 1.0	± 3.0
Return Loss: Input	-	5 - 50 MHz	dB	24	35	-
Return Loss: Input	-	50 - 870 MHz	dB	14	26	-
Return Loss: Input	-	870 - 1000 MHz	dB	11	16	-
Return Loss: Output	-	5 - 1000 MHz	dB	15	22.5	-
Isolation (between outputs)	-	5 - 50 MHz	dB	20	26	-
Isolation (between outputs)	-	50 - 870 MHz	dB	14	22	-
Isolation (between outputs)	-	870 - 1000 MHz	dB	12	15	-

**Absolute Maximum Ratings<sup>1,2</sup>**

Parameter	Absolute Maximum
Max Input Power	1W
DC current	240mA
Operating Temperature	-40°C to +85°C
Storage Temperature	-55°C to +100°C

1. Exceeding any one or combination of these limits may cause permanent damage to this device.
2. M/A-COM does not recommend sustained operation near these survivability limits.

**Recommended PCB Configuration**

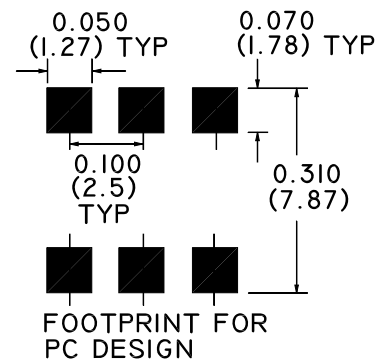

**2 Way 0° Power Divider  
5-1000MHz**

**MAPDCT0029  
V1P**

**Typical Performance Curves:  $T_A = 25^\circ\text{C}$ ,  $Z_0 = 75\Omega$  <sup>1</sup>**

**Insertion Loss**

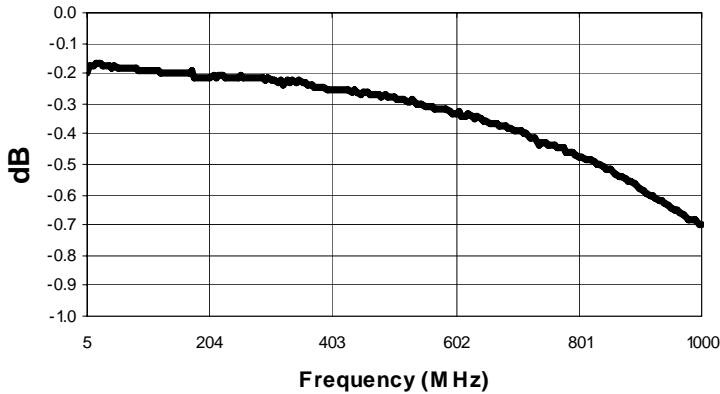

**Isolation**

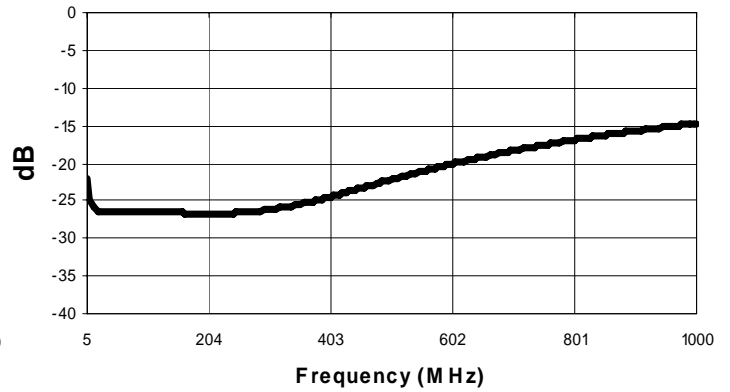

**Amplitude Unbalance**

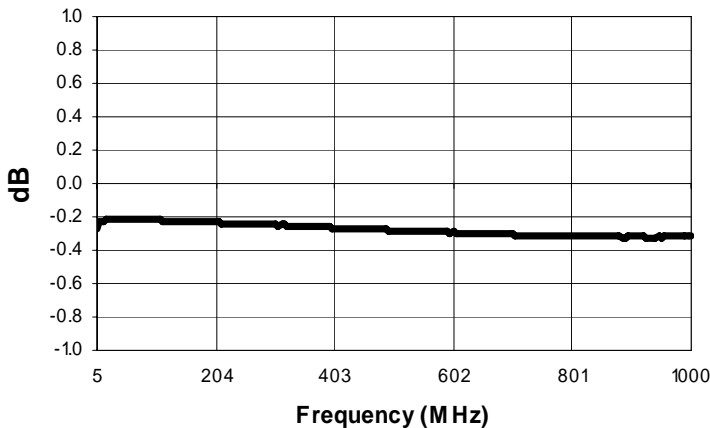

**Phase Unbalance**

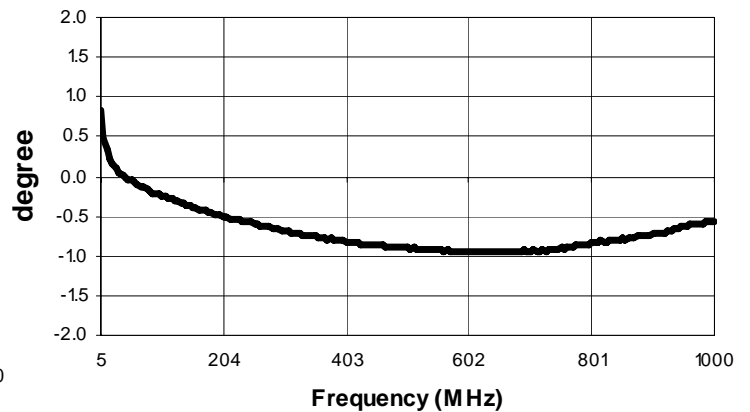

**Return Loss: Input**

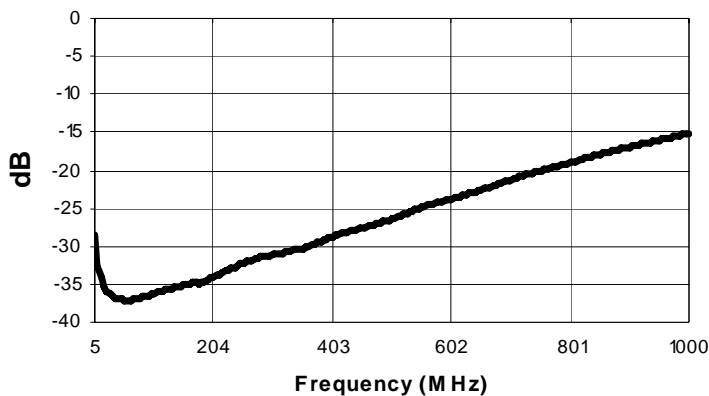

**Return Loss: Output**

